

Dimension™ 650

ArcReach® System

Quick Specs

Heavy Industrial Applications

Fabrication and construction
Heavy manufacturing
MRO — maintenance/repair
Pressure tank/vessel fabrication
Shipbuilding

Processes

MIG (GMAW)
Flux-cored (FCAW)
Submerged arc (SAW)
Stick (SMAW)
TIG (GTAW)
Air carbon arc (CAC-A) cutting and gouging
Rated: 3/8-inch carbons

Input Power 3-phase power
380/460 V, 50/60 Hz

Rated Output 650 A at 44 VDC,
100% duty cycle

Output Range 15–815 A, 10–65 V

Net Weight 158 lb. (71.7 kg)



Game-changing welding technologies can stop you from wasting hours every day.

ArcReach welding technology minimizes the non-value-added time spent walking to and from the power source — and maximizes arc-on time, weld quality and jobsite safety.

When operators have complete control at the feeder or remote — even hundreds of feet away from the power source — it minimizes downtime and maximizes productivity, while improving operator safety and delivering high quality welds.



**More Jobsite
Productivity and
Efficiency**



**Exceptional
Arc Performance**



**Increased
Uptime**



**Improved
Jobsite Safety**



**Maximum Fleet
Compatibility**



**More Operator
Control**

ArcReach®

Remote voltage control at the wire feeder or remote without needing a control cord. See page 2 for more information.



Power source is warrantied for three years, parts and labor.
Original main power rectifier parts are warrantied for five years.



Miller Electric Mfg. LLC

An ITW Welding Company
1635 West Spencer Street
P.O. Box 1079
Appleton, WI 54912-1079 USA

Equipment Sales US and Canada

Phone: 866-931-9730
FAX: 800-637-2315
International Phone: 920-735-4554
International FAX: 920-735-4125

MillerWelds.com



Dimension™ 650 ArcReach® System Advantages



More Jobsite Productivity and Efficiency

ArcReach® capabilities eliminate the time spent tracing weld cables hundreds of feet back to the power source because weld operators can make adjustments at the ArcReach wire feeder or remote.



Exceptional Arc Performance

Dimension 650 ArcReach systems maximize weld quality, reduce training time and minimize weld defects even while using weld cables that are hundreds of feet long.



Maximum Fleet Compatibility

Maximize fleet compatibility and get the benefits of ArcReach when you pair Dimension 650 ArcReach welders and ArcReach feeders with other ArcReach compatible products.



Increased Uptime

Dimension 650 ArcReach welders and ArcReach feeders and remotes have been extensively field-proven and deliver the performance you need with ruggedly constructed internal components and Wind Tunnel Technology™.

- **No more expenses related to maintaining or replacing easily damaged control cords** because the weld cables are used to communicate weld parameters between the wire feeder and power source.



Improved Jobsite Safety

The chances of slip, trip or fall injuries are decreased because ArcReach technology allows weld operators to make parameter changes at the wire feeder/remote instead of having to travel through multistory and cluttered jobsites back to the power source.



More Operator Control

More control for weld operators with quick, easy adjustments at the wire feeder/remote.

- **Inadvertent parameter changes by other jobsite workers can be easily avoided** because connecting an ArcReach accessory from the power source automatically locks out the power source's panel controls.
- **Return to a previous weld process faster** because the power source is restored to its previous settings once the ArcReach accessory is removed.
- **Decrease the chance of an incorrect weld process being used** because Auto-Process Select™ automatically sets the power source to the correct weld process based on the polarity applied to the weld accessory.
- **Fast transition between weld and gouge processes.** There is no need to walk back to the power source to switch between processes. Set the Dimension to gouge, connect a feeder to wire weld, and disconnect the feeder to gouge. Repeat as needed.

ArcReach®

Remote control of the power source without a cord.

ArcReach technology uses the existing weld cable to communicate welding control information between the feeder or remote and power source. This technology eliminates the need for control cords, and their associated problems and costs.

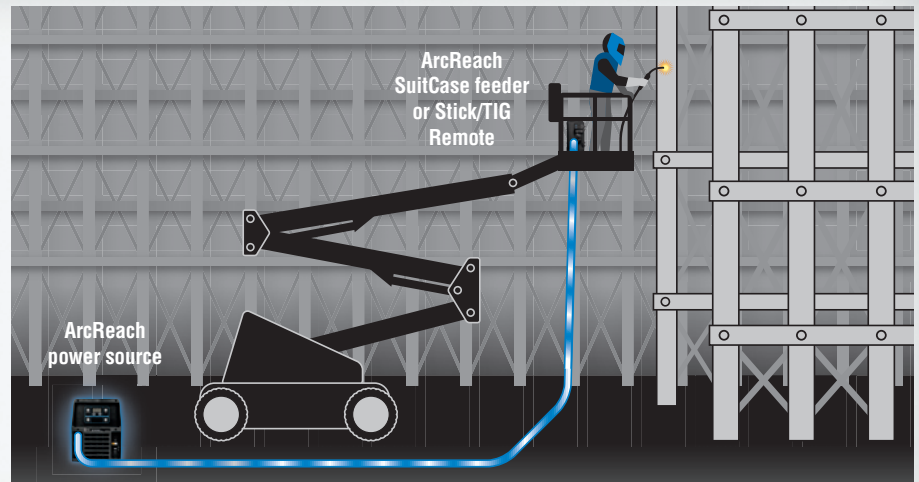

Withstands harsh environments



Rugged and durable inside and out

All-aluminum construction helps the machine resist corrosion for long life.

Exclusive protection input inductor protects machine's performance and reliability from "dirty" input power.

Wind Tunnel Technology™ Internal air flow that protects electrical components and PC boards from dirt, dust, debris... greatly improving reliability

Fan-On-Demand™ operates only when needed reducing noise, power consumption, and the amount of airborne contaminants pulled through the machine.

3.25 inches of ground clearance keeps the machine away from water, mud and dirt to protect interior components.



Dimension™ 650 ArcReach® System Advantages

Smaller and lighter

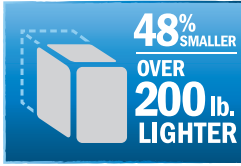

More portable and takes up less floor space

Reduced size and weight results in an easier-to-handle package that exceeds the welding performance of larger, heavier machines. Weighing in at 158 pounds (71.7 kg), the Dimension 650 ArcReach is 3.5 times lighter than the Dimension 652, making it easier to move around the shop, jobsite, or shipyard. It also uses 40 percent less floor space.

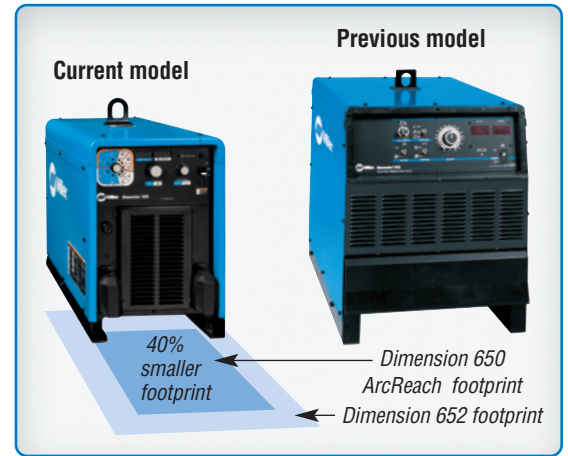

Power efficient

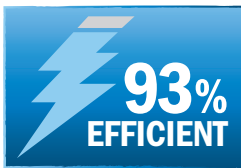

Uses 32% fewer amps than previous model

High electrical efficiency and excellent power factor mean that you can get more welding done using less power. On 460-volt input power, the Dimension 650 ArcReach draws only 43 amps at rated load and can operate on a 50-amp service. Four machines can work at maximum loads simultaneously on a 200-amp service, drawing less amperage than three previous models.

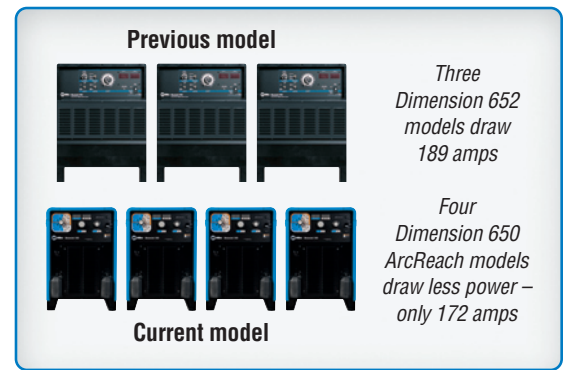

Improved arc performance

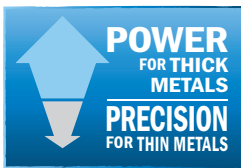

Power and precision

High-quality performance from power-intensive to precise. Knowing quality welds begin with a quality arc, we've significantly improved the performance in all welding processes and made it easy to fine tune the arc to match your personal preferences and welding style.

Gouging mode provides 800 amps of usable power, a full 650 amps of power at 100 percent duty cycle. Perfect for heavy gouging with 3/8-inch carbons.

Three wire modes (GMAW/FCAW/SAW) for simplified setup and optimized arc performance.

- Solid and flux-cored wires with gas offer exceptional short-arc MIG precision to weld thin metals with less risk of distortion or burn-through, and premium flux-cored welding with gas.
- Flux-cored (self-shielded) welding performance is exceptional, especially with wires commonly found in infrastructure construction.
- Sub arc mode provides capability to retrofit into non-digital sub arc applications.

Excellent stick and Lift-Arc™ TIG performance.

Arc control is beneficial when welding with stick and solid wires for easier fine-tuning of tough-to-weld materials and out-of-position applications.

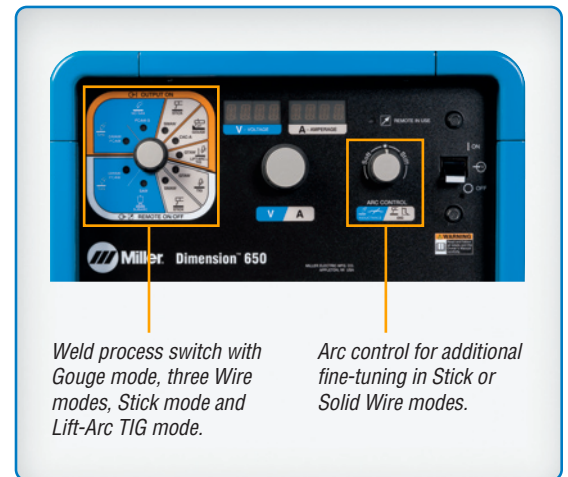

Improved weld quality

Dimension™ 650 ArcReach® Features

Fleet compatibility. ArcReach-equipped power sources and wire feeders work with non-ArcReach equipment; however, the complete ArcReach benefit is only realized with the ArcReach system.

Auto-Bind automatically establishes an exclusive communication between the power source and the wire feeder, using the existing weld cables upon system power up.

LED process indicator. Front panel process selections are illuminated with an LED that identifies the active process. This enables the selected weld process to be seen at a distance from the power source.

- Gouging mode is an optimized stick position for better gouging performance
- Three wire modes (GMAW/FCAW/SAW) for simplified setup and optimized arc performance
 - Solid and flux-cored wires with gas
 - Flux-cored (self-shielded)
 - Sub arc
- Stick mode for all electrode types
- Lift-Arc™ TIG

Standard 14-pin receptacle with Auto-Remote Sense™ for simple connection of remote controls and wire feeders.



Durable weld cable connections

- Serrated hardware for single-wrench application
- Easy double weld cable installation
- Flexible, protective covers prevent incidental contact

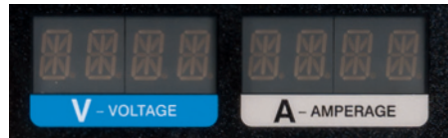

Digital meters with SunVision™ technology enable welding parameters to be viewed with greater clarity than analog meters — at virtually any angle. Meters can be seen clearly even in direct sunlight and can display process settings for quick and easy setup, and preset and actual amperage.

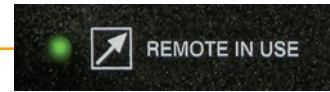

Remote in use indicator provides convenient feedback indicating an ArcReach wire feeder is controlling the power source. While under ArcReach control, process and voltage/amperage adjustments are locked out, preventing accidental changes by personnel other than the welding operator.

Front-panel-mounted power switch is easy to access when in racks or manufacturing cells.



Arc control is active in the stick and solid-wire processes. It allows the operator to customize arc characteristics to match preference, electrode and joint design from a softer arc with more fluid puddle to a stiffer arc with an more controllable puddle. The Star setting is optimized for most applications and pointing the control at Soft or Stiff is optimal for most arc preferences. Control is fully adjustable from 0 to 25 Soft or 0 to 25 Stiff.



Back panel. 20 amps of 120-volt power to run power tools — like grinders, chop saws, drills and lights.

Specifications (Subject to change without notice.)



Amperage/Voltage Ranges	Rated Output	Amps Input at Rated Output, 50/60 Hz				Max. Open-Circuit Voltage	Dimensions	Net Weight
		380 V	460 V	KVA	KW			
10–815 A in CC mode 10–44 V in CV mode 10–65 V in SAW mode	650 A at 44 VDC, 100% duty cycle	53.2	42.8	34	30.7	87	H: 28.187 in. (716 mm) (including lift eye) W: 16.687 in. (424 mm) D: 31.625 in. (803 mm)	158 lb. (71.7 kg)

ArcReach® SuitCase® 8 and 12 Features

Heavy-duty drive motor with electronic wire feed speed control and integrated tachometer ensures wire feed speed accuracy and consistency that rivals the best benchtop feeders — making it easier to produce quality welds. Wide voltage range for small and large wires with no contactor chatter or arc outages.

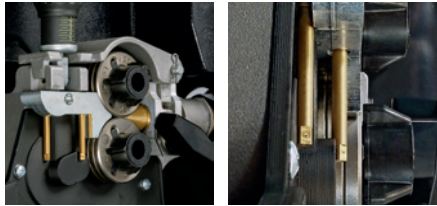

Ultra-low drag inlet guide pins make loading the wire easy and do not deform the wire on the way into the drive rolls. Simply thread the wire through the pins and into drive rolls. There are two ways to advance the wire through the drive roll and into the gun. Either open the pressure arm and thread the wire into the grooves in the drive roll and on into the gun inlet **or** place the wire between the pins and use the jog/purge switch to advance the wire through the drive roll.

Scaled wire pressure knob provides easy adjustment and consistent pressure on the drive rolls and wire. **Wire drive and motor assembly** is



specifically designed for mobile welding applications to provide smooth and consistent wire delivery. Improved motor torque and drive roll system are designed to feed small-diameter solid wire (.023 inch) to large-diameter cored wire (5/64 inch).

Potted and trayed main printed circuit board for the harshest environments adds exceptional reliability. Board has full-trigger isolation so a shorted gun trigger will not affect feeder operation.



Easy process changeover. Simply connect the ArcReach SuitCase feeder to your weld lead and you are ready to go. The power source automatically switches settings to run conventional wire processes.

Wire speed dual schedule reduces wire speed to 87.5 percent of standard speed. Requires a dual schedule gun or dual schedule switch (sold separately).

Digital meters with SunVision™ technology can display voltage and wire speed, and also amperage if desired. Meters can be seen clearly even in direct sunlight.

Set volts and wire feed speed remotely. The simple interface on the feeder allows operators to adjust parameters at the point of use with no control cords.

Impact-resistant polypropylene case with built-in slide rails and the elimination of feeder control cords provides a solid solution to last in harsh environments. Case allows door to open to change wire with feeder in vertical position.

Gun locking tab works with guns having corresponding locking grooves to prevent gun from being pulled out if the feeder is dragged by the gun.

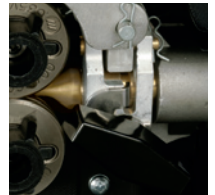

Gas inlet recessed into back of case is protected from incidental contact by the weld cable, ensuring consistent and contaminant-free shielding gas delivery to the gun. **Double-filtered gas valve** helps keep dirt from clogging and affecting gas flow.

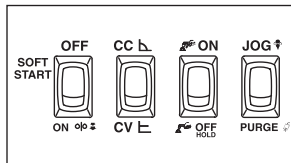

Internal control panel houses soft start, CC/CV, trigger hold and jog/purge switches.

Specifications (Subject to change without notice.)

CC CV DC (Use with CC or CV, DC power sources.)

Model	Input Power	Input Welding Circuit Rating	Wire Feed Speed	Wire Type and Diameter Capacity	Max. Spool Size Capacity	Dimensions	Net Weight
8	Operates on open-circuit voltage and arc voltage: 14–48 VDC/ 110 max. OCV	330 A at 60% duty cycle	50–780 ipm (1.3–19.8 m/min.) dependent on arc voltage	Solid wire: .023–.052 in. (0.6–1.4 mm) Flux-cored: .030–5/64 in. (0.8–2.0 mm)	8 in. (203 mm) 14 lb. (6.4 kg)	H: 12.75 in. (324 mm) W: 7.25 in. (184 mm) D: 18 in. (457 mm)	28 lb. (13 kg)
12		425 A at 60% duty cycle		Solid wire: .023–.052 in. (0.6–1.4 mm) Flux-cored: .030–5/64 in. (0.8–2.0 mm)	12 in. (305 mm) 45 lb. (20 kg)	H: 15.5 in. (394 mm) W: 9 in. (229 mm) D: 21 in. (533 mm)	35 lb. (15.9 kg)

Wire Feeders



ArcReach® SuitCase® 8

951726 With Bernard® BTB Gun 300 A

951728 With Bernard® Dura-Flux™ gun

ArcReach® SuitCase® 12

951729 With Bernard® BTB Gun 300 A

951731 With Bernard® Dura-Flux™ gun

Portable feeder designed to run off of arc voltage. When paired with an ArcReach power source, provides remote control of the power source without a control cord — saving time and money. See literature M/6.55.



70 Series Wire Feeders

S-74 MPa Plus 951291 Single-wire feeder

D-74 MPa Plus 951292 Dual-wire feeder

Order XR-Aluma-Pro™ Plus gun and U-grooved drive rolls separately to match your aluminum needs. Above models are optimized for Dimension™ 650 and have push-pull capability.

S-74S 951196 Single-wire feeder

S-74D 951198 Single-wire feeder

D-74S 951203 Dual-wire feeder

D-74D 951204 Dual-wire feeder

70 Series feeders feature Posifeed™ wire drive assembly and handle a variety of wires. Each includes a 15-foot Bernard® BTB Gun 400 A (two for dual feeders) and .035/.045-inch V-grooved drive rolls. See literature M/3.0.

Remote Controls and Switches



ArcReach® Stick/TIG Remote 301325

When paired with an ArcReach power source, provides remote control of the power source without a cord — saving time and money. See literature AY/14.5.



Wireless Remote Foot Control 300429

For remote current and contactor control. Receiver plugs directly into the 14-pin receptacle of Miller machine. 90-foot (27.4 m) operating range.



Wireless Remote Hand Control 300430

For remote current and contactor control. Receiver plugs directly into the 14-pin receptacle of Miller machine. 300-foot (91.4 m) operating range.



RFCS-14 HD Foot Control 194744

Maximum flexibility is accomplished with a reconfigurable cord that can exit the front, back or either side of the pedal. Foot pedal provides remote current and contactor control. Includes 20-foot (6 m) cord and 14-pin plug.



RHC-14 Hand Control 242211020

20 ft. (6 m) cord

242211100

100 ft. (30.5 m) cord

Miniature hand control for remote current and contactor control. Dimensions: 4 x 4 x 3.25 inches (102 x 102 x 83 mm). Includes cord and 14-pin plug.



RCC-14 Remote Contactor and Current Control 151086

East/west rotary-motion fingertip control attaches to TIG torch using two hook-and-loop fasteners. Allows complete current and contactor control at operator's fingertips. Includes 26.5-foot (8 m) cord and 14-pin plug.



RCCS-14 Remote Contactor and Current Control 043688

North/south rotary-motion fingertip control attaches to TIG torch using two hook-and-loop fasteners. Great for applications that require a finer amperage control. Includes 26.5-foot (8 m) cord and 14-pin plug.



RMLS-14 129337

Momentary- and maintained-contact rocker switch for contactor control. Push forward for maintained contact and backward for momentary contact. Includes 26.5-foot (8 m) cord and 14-pin plug.

Extension Cables for 14-Pin Plugs to 14-Pin Sockets

242208025 25 ft. (7.6 m)

242208050 50 ft. (15.2 m)

242208080 80 ft. (24.4 m)

Extension cables make a direct connection between the power source and remote control or 24 V wire feeder. No messy splicing or adapting required.

Welding Intelligence™



Insight Core™ 14-pin Module 301072

Easy-to-install module brings Insight Core capabilities to your existing fleet. This simplified, Internet-based weld data solution collects, transmits and presents actionable information to any Web-connected device. Insight Core can help you increase productivity, improve weld quality and manage costs.

Genuine Miller® Accessories (Continued)



Dimension™ 650 ArcReach® Rack 907701
 Conveniently houses four Dimension 650 ArcReach power sources for multiple welders. Features include:

- Provision to parallel power sources on common work connections
- Two lifting eyes for transportation
- Rugged skids for dragging or pushing



Running Gear Cylinder Rack 300408
 Small footprint and easily maneuverable, with cylinder rack low enough that you do not have to lift bottles.

Adapter Cord 301259
 115-volt cord for legacy 14-pin accessories. Required to connect to HDC 1500.

Polarity Control 042871

This dual-function control is designed for use with dual wire feeders or any application where electrical isolation and/or polarity reversing of weld current is required. Both functions can be used at the same time.

Process Control Selector 042872

Allows you to easily change weld processes without changing cables — from TIG to MIG or TIG to stick. Also includes features of polarity control. Can be used with any constant-current, constant-voltage or multiprocess CC/CV welding power source.



Industrial MIG 4/0 Kit 300390
 Consists of flowmeter regulator with 10-foot (3 m) gas hose, 10-foot (3 m) 4/0 feeder weld cable with lugs, and 15-foot (4.6 m) work cable with 600-amp C-clamp.

ArcReach® SuitCase® and Stick/TIG Remote Installations

MIG/CAC-A installation diagram

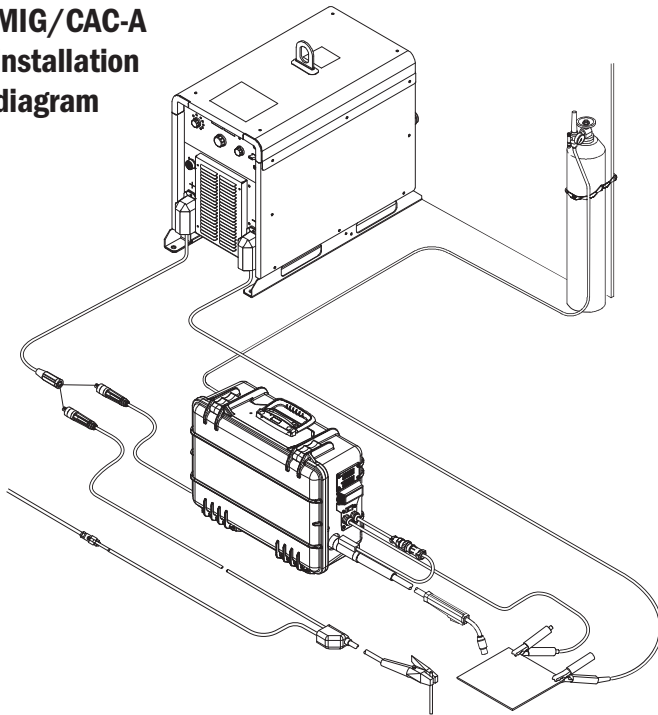

Stick/TIG Remote installation diagram

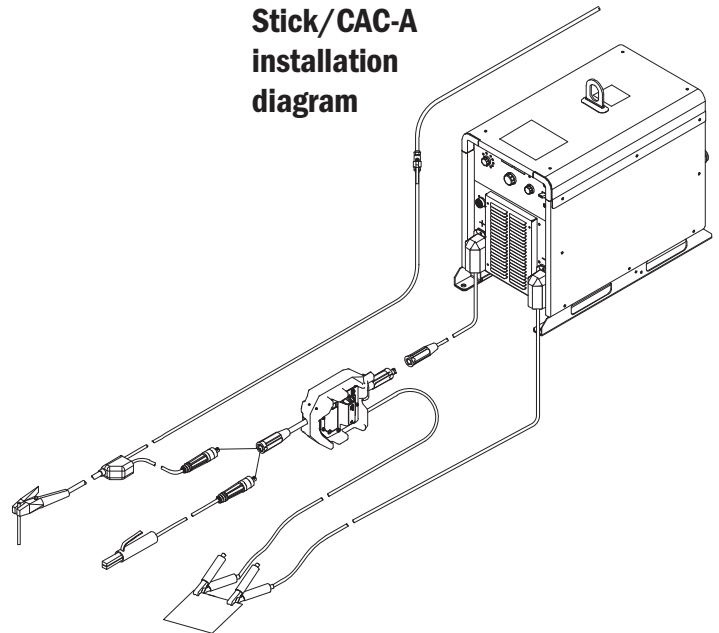

Mounting Specifications

Bottom View

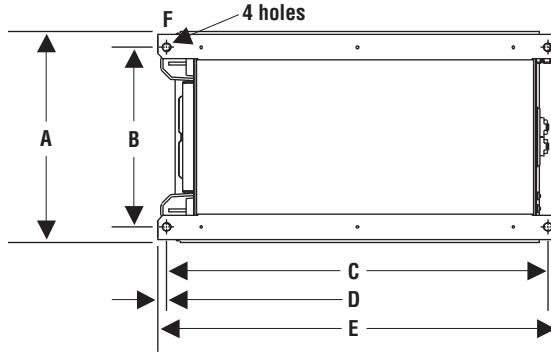

- A. 16.687 in. (424 mm)
- B. 14.25 in. (362 mm)
- C. 30.25 in. (768 mm)
- D. .687 in. (44 mm)
- E. 31.625 in. (803 mm)
- F. .625 in. (17 mm) dia.

Height: 28.187 in. (716 mm)
Width: 16.687 in. (424 mm)
Depth: 31.625 in. (803 mm)

Ordering Information

Equipment and Options	Stock No.	Description	Qty.	Price
Dimension™ 650 ArcReach™ Power Source Only	907617001	380/460 V, 50/60 Hz		
Dimension™ 650 ArcReach™ Rack	907701	4-pack rack		
Wire Feeders				
ArcReach® SuitCase® 8	951726 951728	With Bernard® BTB Gun 300 A. See page 7 and literature M/6.55 With Bernard® Dura-Flux™ gun. See page 7 and literature M/6.55		
ArcReach® SuitCase® 12	951729 951731	With Bernard® BTB Gun 300 A. See page 7 and literature M/6.55 With Bernard® Dura-Flux™ gun. See page 7 and literature M/6.55		
70 Series		See page 7 and See literature M/3.0		
SuitCase® 12RC		See literature M/6.5		
20 Series		See literature M/11.0		
XR™-Controls		See literature M/1.7		
XR™ Push-Pull Guns		See literature M/1.71, M/1.73 and M/1.74		
Swingarc™ Boom Feeders		See literature M/13.11		
Remote Controls				
ArcReach® Stick/TIG Remote	301325	Point-of-use control for stick or TIG welding and gouging with Dimension 650 ArcReach		
Wireless Remote Foot Control	300429	Foot control with wireless 90 ft. (27.4 m) operating range		
Wireless Remote Hand Control	300430	Hand control with wireless 300 ft. (91.4 m) operating range		
RFCS-14 HD	194744	Foot control with 20 ft. (6 m) cord and 14-pin plug		
RHC-14	242211020 242211100	Hand control with 20 ft. (6 m) cord and 14-pin plug Hand control with 100 ft. (30.5 m) cord and 14-pin plug		
RCC-14	151086	Fingertip control (east/west)		
RCCS-14	043688	Fingertip control (north/south)		
RMLS-14	129337	Rocker switch		
Extension Cables		See page 6		
Options and Accessories				
Running Gear Cylinder Rack	300408			
Adapter Cord	301259	115-volt cord for legacy 14-pin accessories. Required to connect to HDC 1500		
Polarity Control	042871			
Process Control Selector	042872			
Industrial MIG 4/0 Kit	300390	Includes flowmeter regulator with 10 ft. (3 m) gas hose, 10 ft. (3 m) 4/0 feeder weld cable with lugs, and 15 ft. (4.6 m) work cable with 600-amp C-clamp		
Welding Intelligence™		See page 7		

Date:

Total Quoted Price:

Distributed by:

